

CAPTURE EVERY DETAIL



WavePro HD
High Definition Oscilloscope

WavePro 804HD-MS 8 GHz High Definition Mixed Signal Oscilloscope 20 GS/s

WavePro HD
HD 4096 2.5 GHz - 8 GHz High Definition Oscilloscopes

- HD4096 Technology 12-bit resolution with 8 GHz bandwidth
- Longest Memory Capture and navigate up to 5 Gpt records
- Deepest Toolbox Powerful signal analysis accelerates insight

HD4096

High Definition Technology



High Signal to Noise Input Amplifiers



High Sample Rate 12-bit ADC's

Low Noise System Architecture

HD4096 technology enables 12 bits of vertical resolution with 8 GHz bandwidth

- Clean, Crisp Waveforms
- More Signal Details
- Unmatched Measurement Precision

Long Memory



Up to 5 Gpts of acquisition memory means exceptionally long capture times at full sample rate and resolution. Intuitive navigation tools make it easy to find events of interest and simplify analysis of long waveforms.

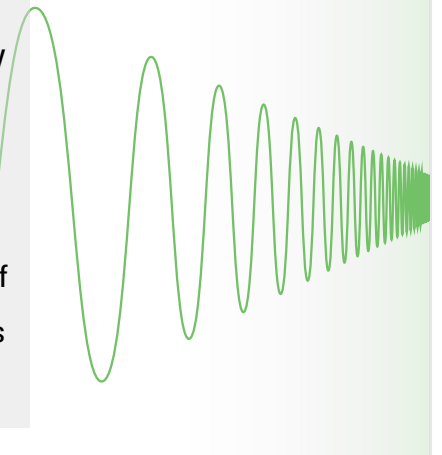

Deep Toolbox

WavePro HD has the greatest breadth and depth of tools to simplify any debug task.





Faster Time to Insight

Insight alone is not enough.

Markets and technologies change too rapidly.

The **timing** of **critical design decisions** is significant.

Faster Time to Insight is what matters.



8 GHz, 20 GS/s, 5 Gpts.
12 bits all the time.



WavePro HD 

Capture Every Detail.

HD4096 TECHNOLOGY - 16X CLOSER TO PERFECT

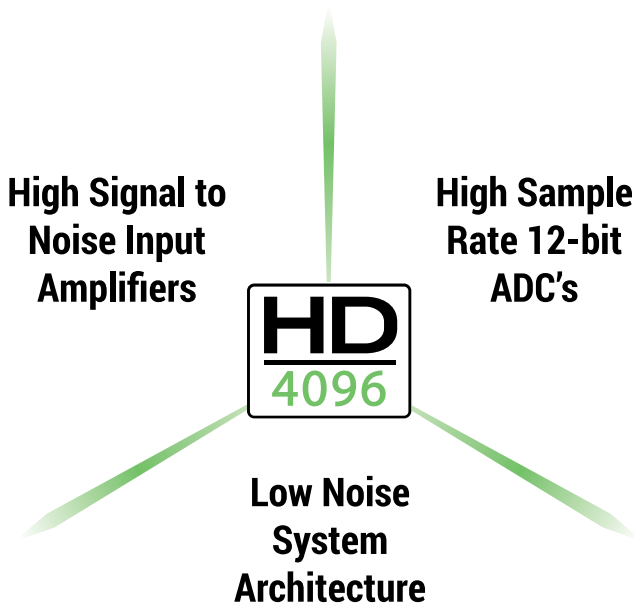

Teledyne LeCroy high definition 12-bit oscilloscopes use unique HD4096 technology to provide superior and uncompromised measurement performance:

- 12-bit ADCs with high sample rates
- High signal-to-noise amplifiers
- Low noise system architecture (to 8 GHz)

Oscilloscopes with HD4096 technology have higher resolution than conventional 8-bit oscilloscopes (4096 vs. 256 vertical levels) and low noise for uncompromised measurement performance. The 12-bit ADCs support capture of fast signals and oscilloscope bandwidth ratings up to 8 GHz, while 20 GS/s sample rate ensures the highest measurement accuracy and precision. The high performance input amplifiers deliver pristine signal fidelity, and the low-noise system architecture provides an ideal signal path to ensure that signal details are delivered accurately to the oscilloscope display – 16x closer to perfect.

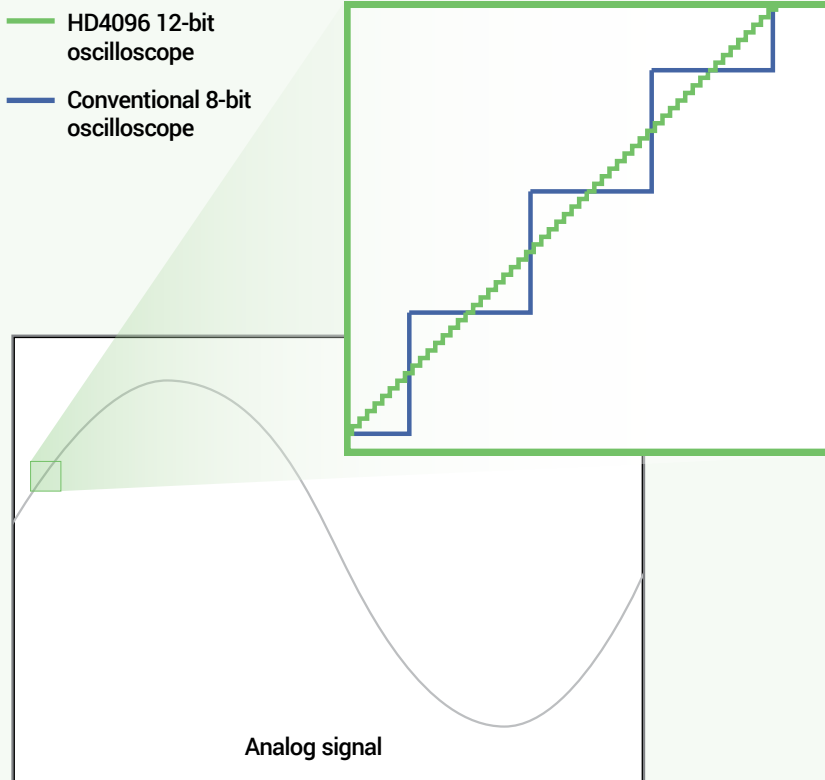

16x Closer to Perfect

16x more resolution

HD4096 technology provides 12 bits of vertical resolution with 16x more resolution compared to conventional 8-bit oscilloscopes. The 4096 discrete vertical levels reduce the quantization error compared to 256 vertical levels. This improves the accuracy and precision of the signal capture and increases measurement confidence.

EXPERIENCE THE DIFFERENCE



Experience HD4096 accuracy, detail, and precision and never use an 8-bit oscilloscope again. Whether the application is general-purpose design and debug, high-precision analog, power electronics, automotive electronics, mechatronics, or other specialized applications, the HD4096 technology provides unsurpassed confidence and measurement capabilities.

Clean, crisp waveforms

When compared to waveforms acquired and displayed using conventional 8-bit oscilloscopes, waveforms captured with HD4096 12-bit technology are dramatically crisper and cleaner, and are displayed more accurately. Once you see a waveform acquired with HD4096 technology, you will not want to go back to using a conventional 8-bit oscilloscope.

More signal details

16x more resolution provides more signal detail. This is especially helpful for wide dynamic range signals in which a full-scale signal must be acquired while at the same time very small amplitude signal details must be analyzed. 12-bit acquisitions combined with the oscilloscope's vertical and horizontal zoom can be used to obtain unparalleled insight to system behaviors and problems.

Unmatched measurement precision

HD4096 technology delivers measurement precision several times better than conventional 8-bit oscilloscopes. Higher oscilloscope measurement precision provides better ability to assess corner cases and design margins, perform root cause analysis, and create the best possible solution for any discovered design issue.

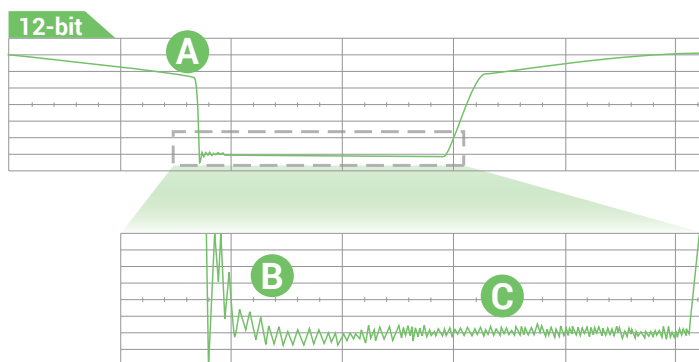
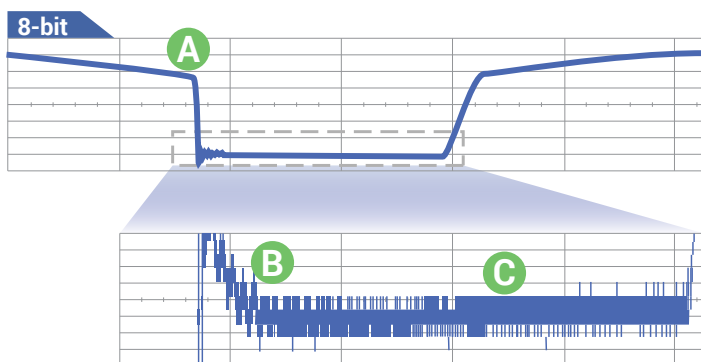

- A Clean, Crisp Waveforms** | Thin traces show the actual waveform with minimal noise interference
- B More Signal Details** | Waveform details can now be clearly seen on an HD4096 12-bit oscilloscope
- C Unmatched Measurement Precision** | Measurements are more precise and not affected by quantization noise

With up to 5 Gpts of acquisition memory, WavePro HD 12-bit oscilloscopes capture events occurring over long periods of time, while still maintaining high sample rate for visibility into the smallest details.



Longest memory

WavePro HD oscilloscopes contain a sophisticated acquisition and memory management architecture that makes 5 Gpt acquisitions fast and responsive. More memory means more visibility into system behavior.

Simple navigation

Long memory and high sample rates capture both millisecond-scale trends and picosecond-scale glitches. WavePro HD oscilloscopes are equipped with an advanced user interface that makes it easy to find features, navigate directly using timebase scale and position knobs, or set up zoom traces - whichever you prefer. Apply analysis tools easily to any type of trace.

No compromise

WavePro HD can acquire 250 ms of data at full 20 GS/s sample rate - and always with 12 bits of resolution. Oscilloscopes with less memory require trading off sample rate for acquisition time.

WavePro HD
5 Gpts @ 20 GS/s
250 ms acquisition time

Competitor A, 20 GS/s
100 ms acquisition time

Competitor B, 20 GS/s
40 ms acquisition time

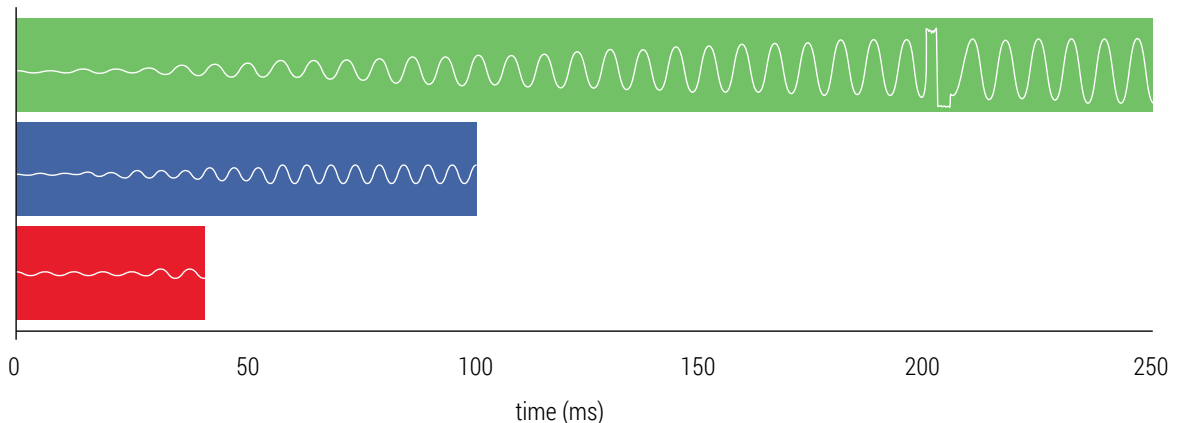

POWERFUL, DEEP TOOLBOX

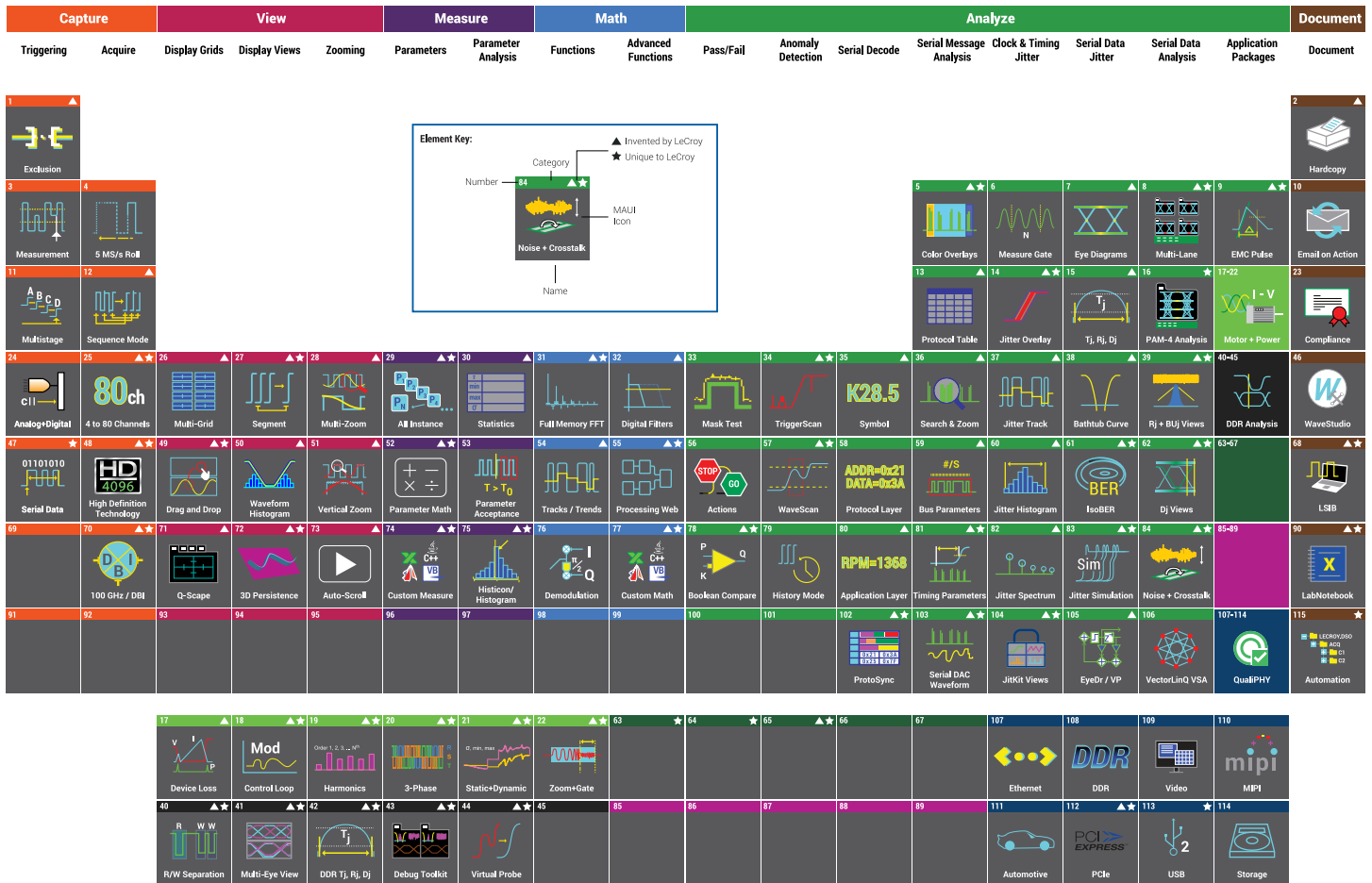

Our heritage

Teledyne LeCroy's 50+ year heritage is in processing long records to extract meaningful insight. We invented the digital oscilloscope and many of the additional waveshape analysis tools.

Our obsession

Our tools and operating philosophy are standardized across much of our product line. This deep toolbox inspires insight; and your moment of insight is our reward.

Our invitation

Our Periodic Table of Oscilloscope Tools explains the toolsets that Teledyne LeCroy has deployed in our oscilloscopes. Visit our interactive website to learn more about them.

teledynelecroy.com/tools

WavePro HD

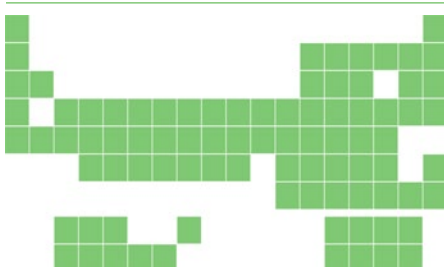

Competitor A

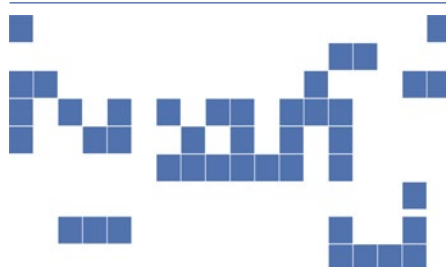

Competitor B

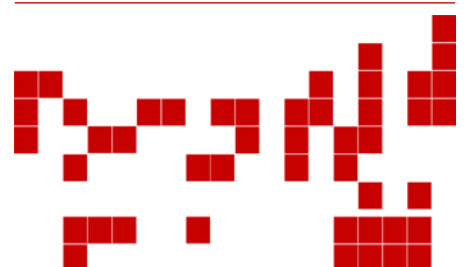

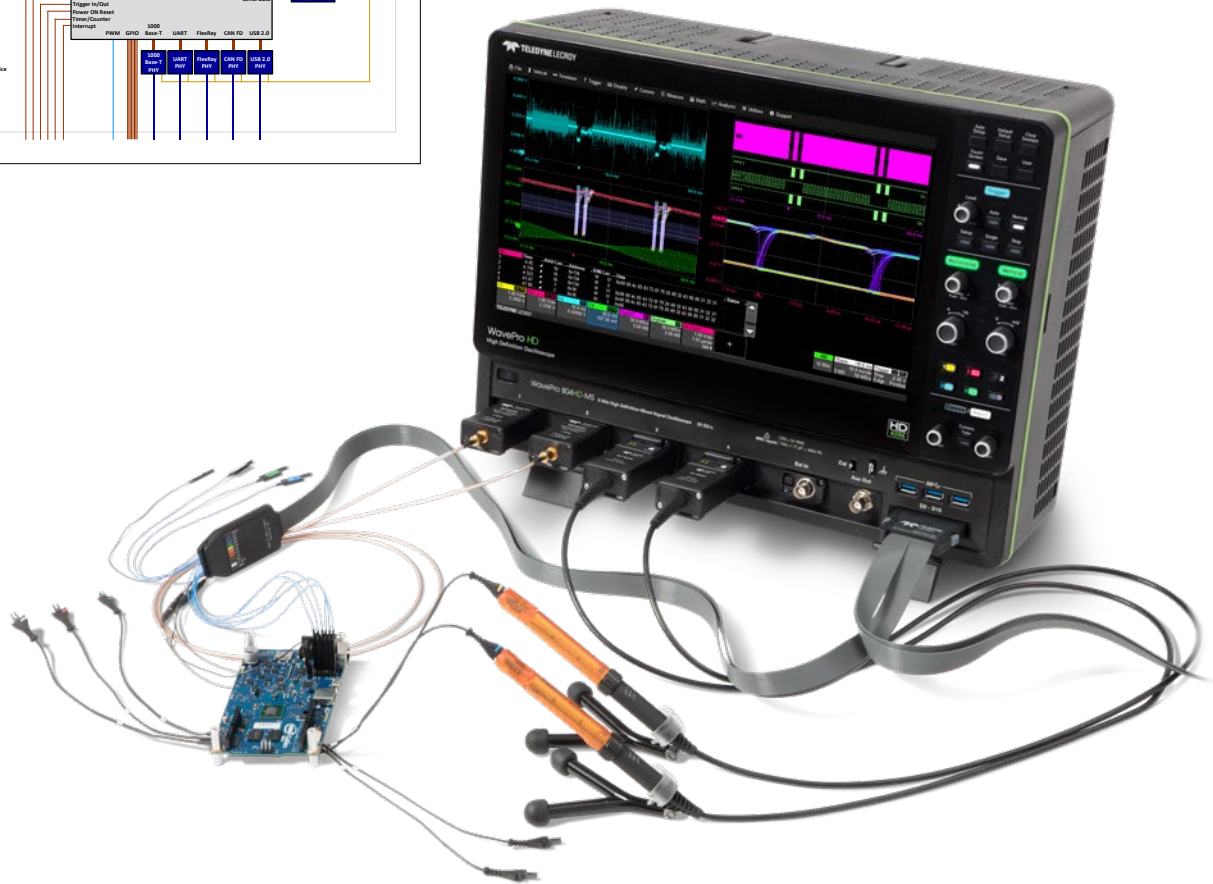
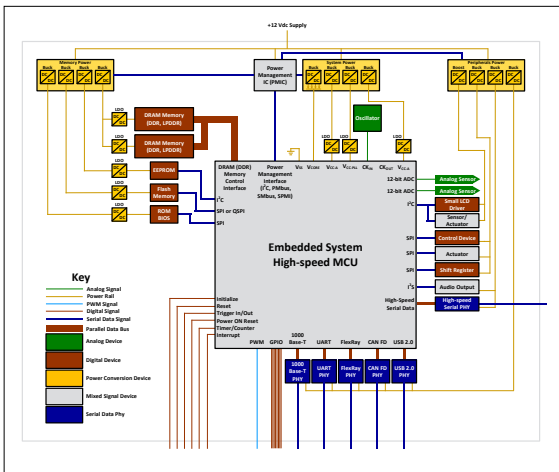

WavePro HD has unsurpassed capabilities to acquire the longest records at the highest resolution for the most comprehensive deeply embedded computing system (analog, digital, serial data and sensor) testing.

Powerful, deep toolbox

More standard math, measure, pass/fail and other toolsets provide faster and more complete insight into circuit problems. Many additional application packages are optionally available to enhance understanding.

Superior serial data toolsets

Comprehensive low-speed serial data triggers and decoders, plus measure/graph and eye diagram testing, provide the best causal analysis. Powerful serial data jitter analysis toolsets and compliance packages simplify complex validation.

Comprehensive probe offering

A wide selection of low voltage, high voltage and current probes will accurately measure every signal in your circuit. New 8 GHz ProBus2 interface is backwards-compatible to the 20+ year legacy of ProBus-compatible probes.

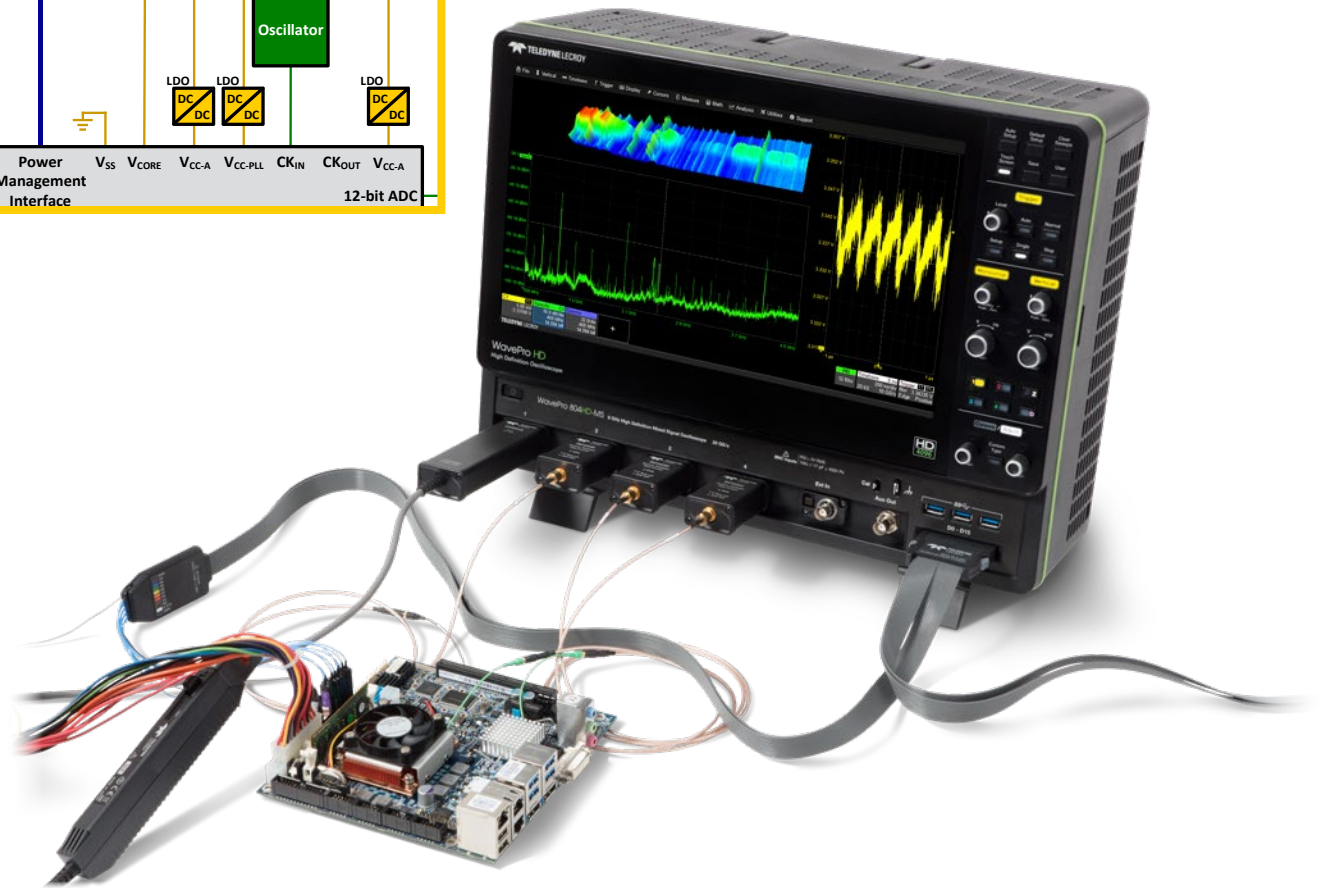
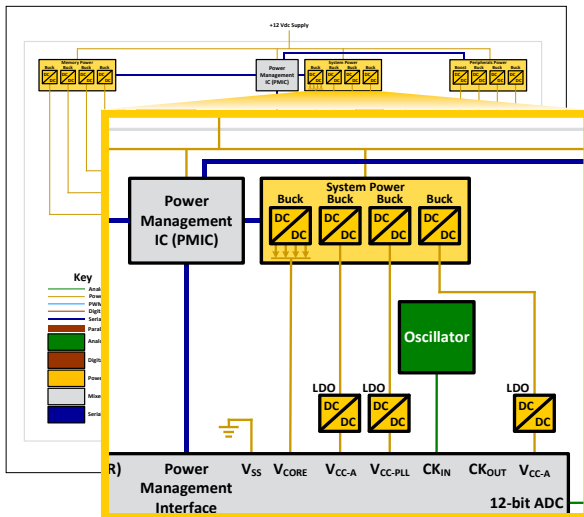

WavePro HD's combination of high bandwidth and high resolution provides the capability to validate and debug all aspects of power supply, delivery and consumption - ensuring complete confidence.

On-die ground bounce

WavePro HD's high bandwidth means accurate characterization of high-speed on-die effects such as ground bounce, while its exceptionally low noise enables identification and root-cause analysis of low-level noise sources.

Find sources of PDN noise

Sensitive measurements such as rail collapse characterization can be made with complete confidence thanks to WavePro HD's high dynamic range and 0.5% gain accuracy. And its low noise floor enables extremely detailed spectral analysis of the PDN noise environment.

Specialized power probes

The combination of WavePro HD and the RP4030 4 GHz Power Rail Probe gives unsurpassed insight into PDN behavior over the widest available bandwidth. A variety of probe tips ensure easy connectivity.

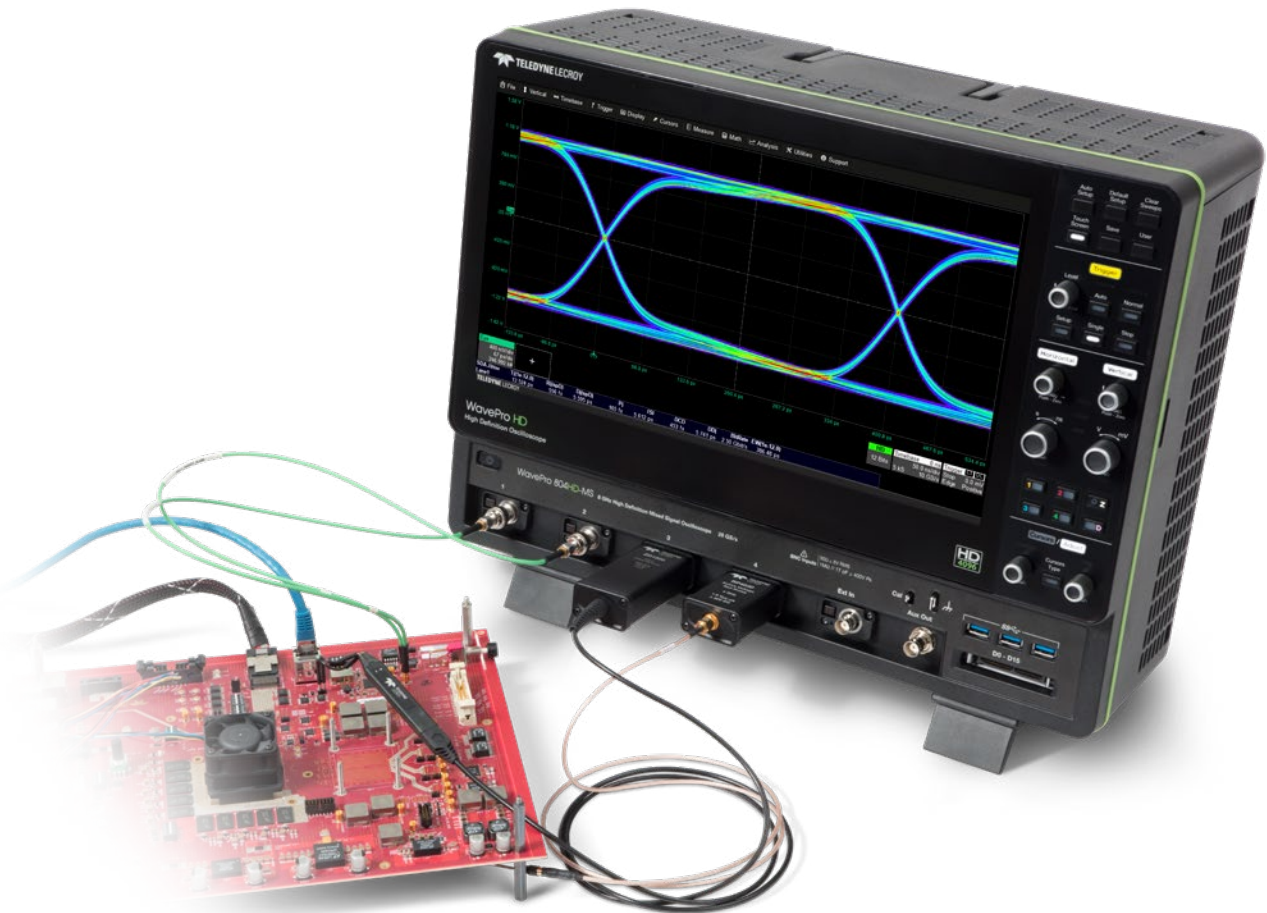

WavePro HD 12-bit oscilloscopes bring the high signal fidelity of HD4096 technology to high-speed serial data analysis, enabling precise measurements with exceptionally low noise and jitter.

High precision, low jitter

WavePro HD's 12-bit resolution, exceptionally low noise and 60 fs timebase jitter mean a low jitter measurement floor, enabling the most accurate serial data jitter and noise measurements possible.

Serial data insight

SDAIII CompleteLinQ provides the most complete set of serial data analysis tools available. Measure and decompose jitter and noise, compare eye diagrams, and leverage unique visualization tools to track down issues.

Compliance made easy

User-friendly QualiPHY serial data compliance packages make validation easy for interfaces such as DDR memory, 10/100/1000BaseT Ethernet, USB and many more.

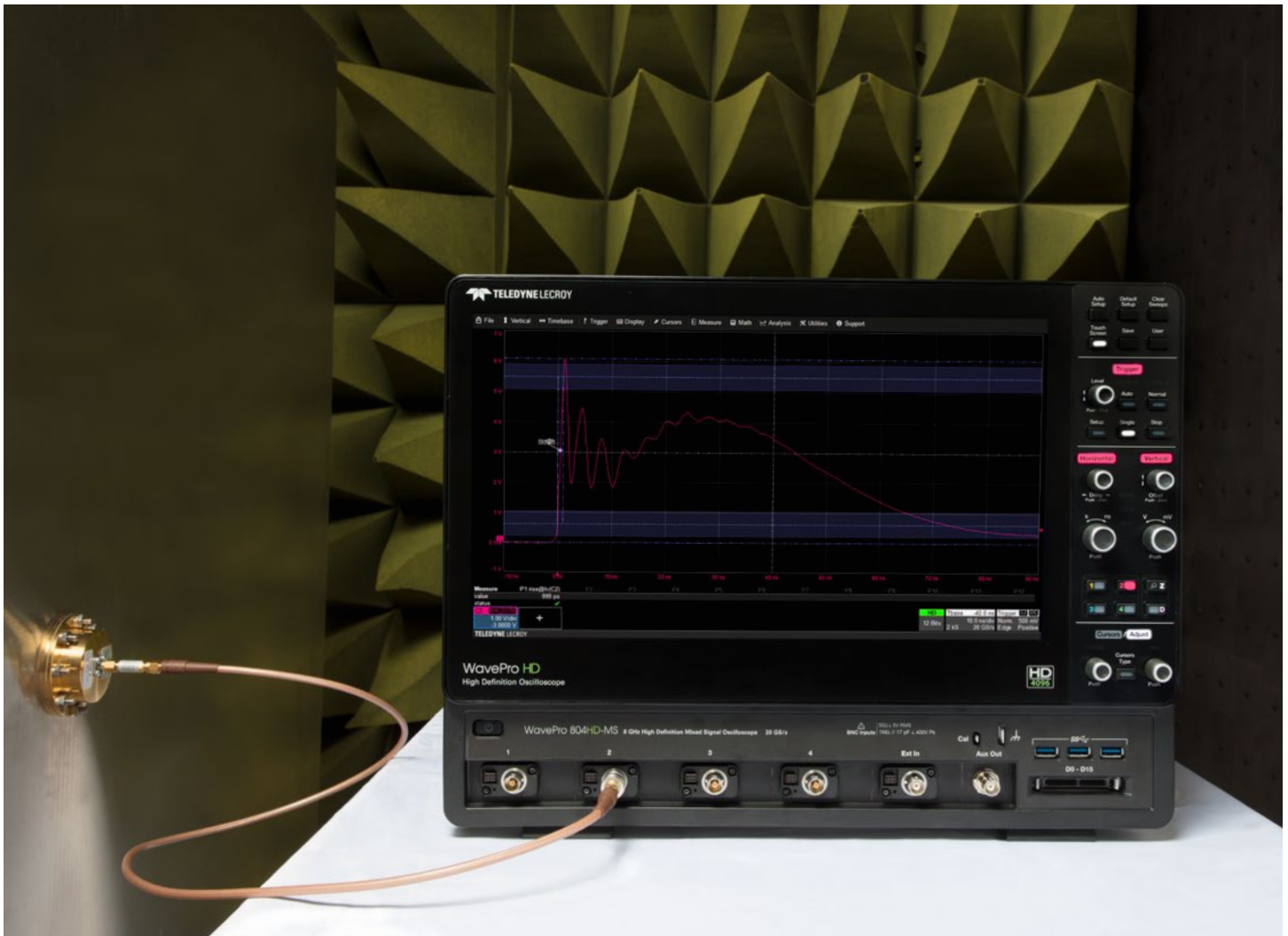

WavePro HD 12-bit oscilloscopes' high sample rate and long memory combine with Teledyne LeCroy's dedicated EMC pulse parameter package to accurately characterize EMC test signals.

Pulse measurement fidelity

Fast pulse rise times may require 2.5 to 4 GHz bandwidth at very high sample rates to ensure measurement confidence. WavePro HD provides the most accurate characterization using 20 GS/s sample rate, 12-bit resolution and 0.5% gain accuracy.

Long capture time

WavePro HD combines high sample rate and exceptionally long memory to enable measurement of many fast transient packets in one acquisition, for fast and simple pulse train and transient testing.

EMC pulse parameter package

Customizable measurements provide values per specific EMC/ESD standards. Level selections can be made to ignore undershoot, overshoot or tail perturbations. Measurement filtering can limit measurement sets or ignore unwanted perturbations. (Optional)

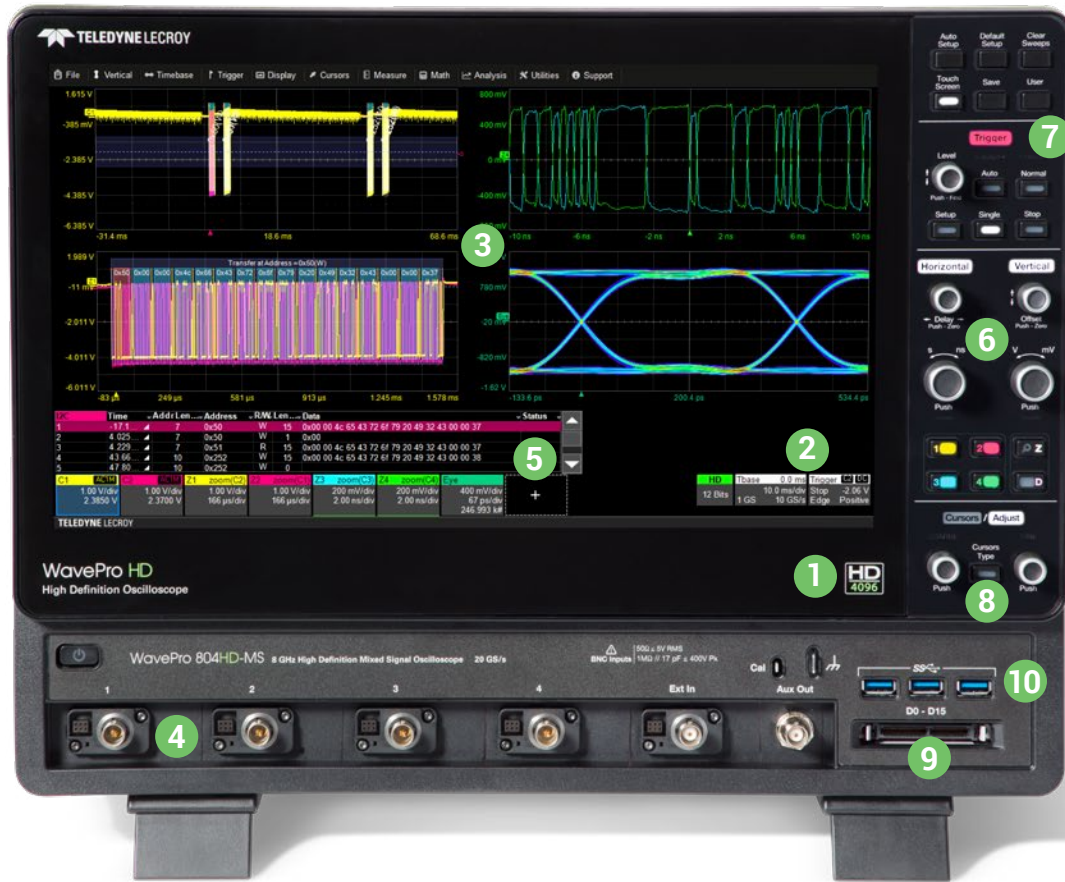

Key Attributes

1. HD4096 technology provides 12-bit resolution up to 8 GHz and 20 GS/s
2. Up to 5 Gpts of acquisition memory enables detailed viewing of long events
3. 15.6" 1900 x 1080 Full HD capacitive touchscreen
4. ProBus2 input supports up to 8 GHz bandwidth while maintaining support for legacy ProBus probes
5. MAUI with OneTouch user interface for intuitive and efficient operation
6. Waveform Control Knobs – Control channel, zoom, math and memory traces with the multiplexed vertical and horizontal knobs
7. Color-coded panel indicators – Trigger, horizontal and vertical indicator colors correspond to the associated waveform on the display
8. Cursor/Adjust Knobs – Enable and position cursors or adjust settings and parameters without opening a menu
9. Mixed Signal Capability – Debug complex embedded designs with integrated 16-channel mixed signal capability
10. Easy connectivity with seven USB 3.1 ports (3 front, 4 side) and UHD (4k) HDMI and DisplayPort outputs
11. USBTMC (Test and Measurement Class) over USB 3.1 for fast data offload
12. Reference Clock Input/Output connectors for connecting to other equipment



Teledyne LeCroy offers an extensive range of probes to meet virtually every probing need.

**Differential Probes
(4 to 8 GHz)**

Various
(see ordering information)



General purpose high-bandwidth probes with high dynamic range and offset. Wide variety of tips and leads available, including solder-in, QuickLink solder-in, HiTemp solder-in, browser tip, square-pin, and SMA/SMP lead (8 GHz model only).

**ZS Series High Impedance
Active Probes**

ZS1000, ZS1000-QUADPAK
ZS1500, ZS1500-QUADPAK
ZS2500, ZS2500-QUADPAK
ZS4000



High input impedance (1 M Ω), low 0.9 pF input capacitance and an extensive set of probe tips and ground accessories make these low-cost, single-ended probes ideal for a wide range of applications. The ZS Series is available up to 4 GHz bandwidth.

**Differential Probes
(200 MHz – 1.5 GHz)**

ZD1500, ZD1000,
ZD500, ZD200
AP033



High bandwidth, excellent common-mode rejection ratio (CMRR) and low noise make these active differential probes ideal for applications such as automotive electronics and data communications. AP033 provides 10x gain for high-sensitivity measurement of series/shunt resistor voltages.

**Active Voltage/Power
Rail Probe**

RP4030



Specifically designed to probe a low impedance power/voltage rail. The RP4030 has 30 V built-in offset adjust, low attenuation (noise), and high DC input impedance with 4 GHz of bandwidth. Featuring a wide assortment of tips and leads, including solder-in and U.FL receptacle connections.

**High Voltage
Fiber Optically-isolated Probe**

HVFO103



The HVFO103 is a compact, simple, affordable probe for measurement of small signals (gate-drives, sensors, etc.) floating on an HV bus in power electronics designs, or for EMC, EFT, ESD and RF immunity testing sensor monitoring. Suitable for up to 35kV common-mode. 140 dB CMRR.

**HVD Series High Voltage
Differential Probes**

HVD3102A, HVD3106A(1 kV)
HVD3206A (2 kV)
HVD3605A (6 kV)



Available with 1, 2 or 6 kV common-mode ratings. Excellent CMRR (65 dB @ 1 MHz) at high frequencies is combined with low inherent noise, wide differential voltage range, high offset voltage capabilities, and 1% gain accuracy. The ideal probe for power conversion system test.

**High Voltage
Passive Probes**

HVP120,
PPE4KV, PPE5KV, PPE6KV



The HVP and PPE Series includes four fixed-attenuation probes covering a range from 1 kV to 6 kV. These probes are ideal for lightning/surge or EFT testing, or for probing in-circuit beyond the range of a LV-rate passive probe.

Current Probes

CP030, CP030-3M, CP030A
CP031, CP031A
CP150, CP150-6M
CP500, DCS025



Available in bandwidths up to 100 MHz with peak currents of 700 A and sensitivities to 1 mA/div. Extra-long cables (3 or 6 meters) available on some models. Ideal for component or power conversion system input/output measurements. DCS015 deskew calibration source also available.

**Probe and Current Sensor
Adapters**

TPA10, TPA10-QUADPAK
CA10, CA10-QUADPAK



TPA10 adapts supported Tektronix TekProbe-compatible probes to Teledyne LeCroy ProBus interface. CA10 is a programmable adapter for third-party current sensors that have voltage or current outputs proportional to measured current. QUADPAKs of four pieces each are available.

	WavePro 254HD WavePro 254HD-MS	WavePro 404HD WavePro 404HD-MS	WavePro 604HD WavePro 604HD-MS	WavePro 804HD WavePro 804HD-MS
Vertical - Analog Channels				
Analog Bandwidth @ 50 Ω (-3 dB)	2.5 GHz	4 GHz	6 GHz on 2 Ch 4 GHz on 4 Ch	8 GHz on 2 Ch 4 GHz on 4 Ch
Analog Bandwidth @ 1 MΩ (-3 dB) *	500 MHz (typical)	500 MHz (typical)	500 MHz (typical)	500 MHz (typical)
Rise Time (10–90%, 50 Ω – test limit)	166 ps	104 ps	71 ps	57.5 ps
Rise Time (20–80%, 50 Ω – typical)	117 ps	73 ps	50 ps	40.5 ps
Input Channels	4			
Vertical Resolution	12 bits; up to 15 bits with enhanced resolution (ERES)			
Effective Number of Bits (ENOB) **	7.8 bits	7.5 bits	7.2 bits	7.0 bits
Vertical Noise Floor (rms, 50 Ω)				
1 mV/div	155 μV	228 μV	285 μV	315 μV
2 mV/div	155 μV	228 μV	285 μV	315 μV
5 mV/div	155 μV	228 μV	285 μV	315 μV
10 mV/div	155 μV	228 μV	285 μV	315 μV
20 mV/div	191 μV	275 μV	360 μV	420 μV
50 mV/div	429 μV	633 μV	835 μV	983 μV
100 mV/div	889 μV	1.31 mV	1.70 mV	1.95 mV
200 mV/div	1.44 mV	2.06 mV	2.70 mV	3.16 mV
500 mV/div	3.66 mV	5.16 mV	6.70 mV	7.76 mV
1 V/div	6.70 mV	9.17 mV	11.93 mV	13.81 mV
Sensitivity	50 Ω: 1 mV–1 V/div, fully variable; 1 MΩ: 1 mV–10 V/div, fully variable			
DC Vertical Gain Accuracy (Gain Component of DC Accuracy)	±(0.5%) F.S, offset at 0 V			
Channel-Channel Isolation	70 dB up to 200 MHz 60 dB up to 500 MHz 50 dB up to 1 GHz 40 dB up to 2.5 GHz	70 dB up to 200 MHz 60 dB up to 500 MHz 50 dB up to 1 GHz 40 dB up to 2.5 GHz 30 dB up to 4 GHz	70 dB up to 200 MHz 60 dB up to 500 MHz 50 dB up to 1 GHz 40 dB up to 2.5 GHz 30 dB up to 6 GHz	70 dB up to 200 MHz 60 dB up to 500 MHz 50 dB up to 1 GHz 40 dB up to 2.5 GHz 30 dB up to 8 GHz
Offset Range	50 Ω, BWL ≤ 1 GHz: 1 mV to 4.95 mV: ±1.6 V, 5 mV to 9.9 mV: ±4 V 10 mV to 19.8 mV: ±8 V, 20 mV to 1 V: ±10 V 50 Ω, BWL > 1 GHz: 1 mV/div to 34.5 mV/div: ±0.5 V, 35 mV/div to 87 mV/div: ±1.25 V 88 mV/div to 220 mV/div: ±3 V, 225 mV/div to 1 V/div: ±5 V 1 MΩ: 1 mV to 4.95 mV: ±1.6 V, 5 mV to 9.9 mV: ±4 V 10 mV to 19.8 mV: ±8 V, 20 mV to 100 mV: ±16 V 102 mV to 198 mV: ±80 V, 200 mV to 1 V: ±160 V 1.02 V to 10 V: ±400 V			
DC Vertical Offset Accuracy	±(0.5% of offset value + 0.5% FS + 1 mV)			
Maximum Input Voltage	50 Ω, ≤1 GHz BWL: 5 Vrms, ±10 V Peak 50 Ω, >1 GHz BWL: ±2 V max. up to 34.5 mV/div, ±5 V max. 35 mV/div to 87 mV/div, 5.5 Vrms >87 mV/div 1 MΩ: 400 V max. (Peak DC+AC)			
Input Coupling	1 MΩ: AC, DC, GND; 50 Ω: DC, GND			
Input Impedance	50 Ω ±2% or 1 MΩ 14 pF, 10 MΩ 9.5 pF			
Bandwidth Limiters	20 MHz, 200 MHz, 500 MHz, 1 GHz	20 MHz, 200 MHz, 500 MHz, 1 GHz, 2.5 GHz	20 MHz, 200 MHz, 500 MHz, 1 GHz, 2.5 GHz, 4 GHz	20 MHz, 200 MHz, 500 MHz, 1 GHz, 2.5 GHz, 4 GHz, 6 GHz
Rescaling	Length: meters, inches, feet, yards, miles; Mass: grams, slugs; Temperature: Celsius, Fahrenheit, Kelvin; Angle: radian, arcdegr, arcmin, arcsec, cycles, revolutions, turns; Velocity: m/s, in/s, ft/s, yd/s, miles/s; Acceleration: m/s ² , in/s ² , ft/s ² , g ₀ ; Volume: liters, cubic meters, cubic inches, cubic feet, cubic yards; Force (Weight): Newton, grain, ounce, pound; Pressure: Pascal, bar, atmosphere (technical), atmosphere (standard), torr, psi; Electrical: Volts, Amps, Watts, Volt-Amperes, Volt-Amperes reactive, Farad, Coulomb, Ohm, Siemen, Volt/meter, Coulomb/m ² , Farad/meter, Siemen/meter, power factor; Magnetic: Weber, Tesla, Henry, Amp/meter, Henry/meter; Energy: Joule, BTU, calorie; Rotating Machine: radian/second, frequency, revolution/second, revolution/minute, N·m, lb-ft, lb-in, oz-in, Watt, horsepower; Other: %			
Horizontal - Analog Channels				
Timebases	Internal timebase common to 4 input channels			
Time/Division Range	20 ps/div to 1 ks/div			
Clock Accuracy	±100 ppb for 5 to 40 C + 0.10 ppm/year from calibration			
Sample Clock Jitter	Up to 10 μs Acquired Time Range: 60 fsrms (Internal Timebase Reference) Up to 10 ms Acquired Time Range: 100 fsrms (Internal Timebase Reference)			

* When used with PP023 passive probes

** Measured at 100 mV/div, 7 divisions (87.5% full-scale)

WavePro 254HD
WavePro 254HD-MS

WavePro 404HD
WavePro 404HD-MS

WavePro 604HD
WavePro 604HD-MS

WavePro 804HD
WavePro 804HD-MS

Horizontal - Analog Channels (cont'd)

Delta Time Measurement Accuracy	$\sqrt{2} * \sqrt{\left(\frac{Noise}{SlewRate}\right)^2 + (Sample\ Clock\ Jitter)^2 (RMS) + (clock\ accuracy * reading) (seconds)}$
Jitter Measurement Floor	$\sqrt{\left(\frac{Noise}{SlewRate}\right)^2 + (Sample\ Clock\ Jitter)^2 (RMS, seconds, TIE)}$
Channel-Channel Deskew Range	±9 x time/div. setting, 100 ms max., each channel
External Timebase Reference (Input)	10 MHz ±25 ppm at 0 to 10 dBm into 50 Ohms
External Timebase Reference (Output)	10 MHz, 5.0 dBm ±2.5 dBm, sinewave synchronized to reference being used (internal or external reference)

Acquisition - Analog Channels

Sample Rate (Single-Shot)	10 GS/s on 4 Ch, 20 GS/s on 2 Ch
Memory Length Options (4 Ch / 2 Ch) (Number of segments in sequence acquisition mode)	<p>Standard: 50 Mpts / 100 Mpts (65,535 segments)</p> <p>WPHD-200MPT Option: 100 Mpts / 200 Mpts (65,535 segments)</p> <p>WPHD-500MPT Option: 250 Mpts / 500 Mpts (65,535 segments)</p> <p>WPHD-1000MPT Option: 500 Mpts / 1000 Mpts (65,535 segments)</p> <p>WPHD-2000MPT Option: 1000 Mpts / 2000 Mpts (65,535 segments)</p> <p>WPHD-5000MPT Option: 2500 Mpts / 5000 Mpts (65,535 segments)</p> <p>Maximum analysis memory: 500 Mpts per channel</p>
Intersegment time	1.5 μs
Averaging	Summed averaging to 1 million sweeps; continuous averaging to 1 million sweeps (waveforms of ≤ 500 Mpts)
Interpolation	Linear or Sinx/x (2 pt and 5 pt) (waveforms of ≤ 500 Mpts)

Vertical, Horizontal, Acquisition - Digital Channels (-MS Models only)

Maximum Input Frequency	250 MHz
Minimum Detectable Pulse Width	2 ns
Input Dynamic Range	±20 V
Input Impedance (Flying Leads)	100 kΩ 5 pF
Input Channels	16 Digital Channels
Maximum Input Voltage	±30 V Peak
Minimum Input Voltage Swing	400 mV
Threshold Groupings	Pod 2: D15 to D8, Pod 1: D7 to D0
Threshold Selections	TTL, ECL, CMOS (2.5 V, 3.3 V, 5 V), PECL, LVDS or User Defined
Threshold Accuracy	±(3% of threshold setting + 100 mV)
User Defined Threshold Range	±10 V in 20 mV steps
User Defined Hysteresis Range	100 mV to 1.4 V in 100 mV steps
Sample Rate	1.25 GS/s
Record Length	<p>Standard: 50 Mpts</p> <p>WPHD-200MPT Option: 100 Mpts</p> <p>WPHD-500MPT Option: 125 Mpts</p> <p>WPHD-1000MPT Option: 125 Mpts</p> <p>WPHD-2000MPT Option: 125 Mpts</p> <p>WPHD-5000MPT Option: 125 Mpts</p>
Channel-to-Channel Skew	350 ps

Triggering System

Modes	Normal, Auto, Single, and Stop (acquisition of ≤ 500 Mpts) Single (acquisition of > 500 Mpts)
Sources	Any input channel, Ext, Ext/10, Line, or Fast Edge; slope and level unique to each source (except Line and Fast Edge)
Coupling	DC, AC, HFRej, LFRej
Pre-trigger Delay	0 to 100% of memory size
Post-trigger Delay	No limitation
Hold-off	From 1 ns up to 20 s or from 1 to 99,999,999 events
Trigger and Interpolator Jitter	≤ 2.5 ps RMS (typical), < 0.1 ps RMS (typical, software assisted)

	WavePro 254HD WavePro 254HD-MS	WavePro 404HD WavePro 404HD-MS	WavePro 604HD WavePro 604HD-MS	WavePro 804HD WavePro 804HD-MS
Triggering System (cont'd)				
Internal Trigger Level Range	±4.1 div from center (typical)			
External Trigger Level Range	Ext (±0.4 V); Ext/10 (±4 V)			
Maximum Trigger Rate	650,000 waveforms/second			
Trigger Sensitivity with Edge Trigger (Ch 1–4)	0.75 div	0.75 div	0.75 div @ < 5 GHz 1.5 div @ < 6 GHz	2.25 div @ < 8 GHz 1.25 div @ < 4.5 GHz 0.75 div @ < 1 GHz
External Trigger Sensitivity, (Edge Trigger)	0.5 div @ < 1 GHz			
Max. Trigger Frequency, SMART Trigger	2.0 GHz @ ≥ 10 mV/div (minimum triggerable width 200 ps)			

Trigger Types

Edge	Triggers when signal meets slope (positive, negative, or either) and level condition.
Width	Triggers on positive or negative glitches with selectable widths. Minimum width: 500 ps, maximum width: 20 s
Glitch	Triggers on positive or negative glitches with selectable widths. Minimum width: 200 ps, maximum width: 20 s
Window	Triggers when signal exits a window defined by adjustable thresholds.
Pattern	Logic combination (AND, NAND, OR, NOR) of 5 inputs (4 channels and external trigger input). Each source can be high, low, or don't care. The high and low level can be selected independently. Triggers at start or end of pattern.
TV-Composite Video	Triggers NTSC or PAL with selectable line and field; HDTV (720p, 1080i, 1080p) with selectable frame rate (50 or 60 Hz) and line; or CUSTOM with selectable fields (1 to 8), lines (up to 2000), frame rates (25, 30, 50, or 60 Hz), interlacing (1:1, 2:1, 4:1, 8:1), or synch pulse slope (positive or negative).
Runt	Trigger on positive or negative runts defined by two voltage limits and two time limits. Select between 1 ns and 20 ns.
Slew Rate	Trigger on edge rates. Select limits for dV, dt, and slope. Select edge limits between 1 ns and 20 ns.
Interval	Triggers on intervals selectable between 1 ns and 20 s.
Dropout	Triggers if signal drops out for longer than selected time between 1 ns and 20 s.
Exclusion Triggering	Trigger on intermittent faults by specifying the expected behavior and triggering when that condition is not met.
Measurement Trigger	Select from a large number of measurement parameters trigger on a measurement value with qualified limits.
Multi-stage: Qualified	Triggers on any input source only if a defined state or edge occurred on another input source. Delay between sources is selectable by time or events. (Note: event B pattern trigger cannot include analog channels).
Multi-stage: Qualified First	In Sequence acquisition mode, triggers repeatedly on event B only if a defined pattern, state or edge (event A) is satisfied in the first segment of the acquisition. Holdoff between sources is selectable by time or events. (Note: event B pattern trigger cannot include analog channels).

Low Speed Serial Protocol Triggering (Optional)

I2C, SPI (SPI, SSPI, SIOP), UART-RS232, CAN1.1, CAN2.0, CAN FD, LIN, FlexRay, MIL-STD-1553, USB 1.x/2.0

Measurement Tools

Measurement Functionality	Display up to 12 measurement parameters together with statistics including mean, minimum, maximum, standard deviation, and total number. Each occurrence of each parameter is measured and added to the statistics table. Histograms provide a fast, dynamic view of parameters and waveshape characteristics. Parameter math allows addition, subtraction, multiplication, or division of two different parameters. Parameter gates define the location for measurement on the source waveform. Parameter accept criteria define allowable values based on range setting or waveform state.
Measurement Parameters - Horizontal + Jitter	Cycles (number of), Delay (from trigger, 50%), Δ Delay (50%), Duty Cycle (50%, @level), Edges (number of, @level), Fall Time (90-10, @levels), Frequency (50%, @level), Half Period (@level), Hold Time (@level), N Cycle Jitter (peak-peak), Number of Points, Period (50%, @level), Δ Period (@level), Phase (@level), Rise Time (10-90, @levels), Setup (@levels), Skew (@levels), Slew Rate (@levels), Time Interval Error (@level), Time (@level), Δ Time (@level), Width (50%, @level), Δ Width (@level), X(value)@max, X(value)@min
Measurement Parameters - Vertical	Amplitude, Base, Level@X, Maximum, Mean, Median, Minimum, Peak-to-Peak, RMS, Std. Deviation, Top
Measurement Parameters - Pulse	Area, Base, Fall Time (90-10, 80-20, @levels), Overshoot (positive, negative), Rise Time (10-90, 80-20, @levels), Top, Width (50%)
Measurement Parameters - Statistical (on Histograms)	Full Width (@ Half Max, @%), Amplitude, Base, Peak@MaxPopulation, Maximum, Mean, Median, Minimum, Mode, Range, RMS, Std. Deviation, Top, X(value)@Peak, Peaks (number of), Percentile, Population (@bin, total)

Math Tools

Math Functionality	Display up to 12 math functions traces (F1-F12). The easy-to-use graphical interface simplifies setup of up to two operations on each function trace, and function traces can be chained together to perform math-on-math.
Math Operators - Basic Math	Average (summed), Average (continuous), Difference (-), Envelope, Floor, Invert (negate), Product (x), Ratio (/), Reciprocal, Rescale (with units), Roof, Sum (+)
Math Operators - Digital (incl. with MSO models/options)	Digital AND, Digital DFlipFlop, Digital NAND, Digital NOR, Digital NOT, Digital OR, Digital XOR
Math Operators - Filters	Enhanced resolution (to 15 bits vertical), Interpolate (cubic, quadratic, sinx/x)
Math Operators - Frequency Analysis	FFT (power spectrum, magnitude, phase, power density, real, imaginary, magnitude squared) up to full record length. Select from Rectangular, VonHann, Hamming, FlatTop and Blackman Harris windows.
Math Operators - Functions	Absolute value, Correlation (two waveforms), Derivative, Deskew (resample), Exp (base e), Exp (base 10), Integral, Invert (negate), Log (base e), Log (base 10), Reciprocal, Rescale (with units), Square, Square root, Zoom (identity)
Math Operators - Other	Segment, Sparse

WavePro 254HD
WavePro 254HD-MS

WavePro 404HD
WavePro 404HD-MS

WavePro 604HD
WavePro 604HD-MS

WavePro 804HD
WavePro 804HD-MS

Measurement and Math Integration

Histograms to display statistical distributions of up to 2 billion measurement parameters. Trend (datalog) of up to 1 million measurement parameters. Track (display parameter vs. time, time-correlated to acquisitions) any parameter. Persistence histogram and persistence trace (mean, range, sigma)

Pass/Fail Testing

Display up to 12 Pass/Fail queries using a Single or Dual Parameter Comparison (compare All values, or Any value $<$, \leq , $=$, $>$, \geq , within limit $\pm\Delta$ value or %) or Mask Test (pre-defined or user-defined mask, waveform All In, All Out, Any In, or Any Out conditions). Combine queries into a boolean expression to Pass or Fail IF "All True", "All False", "Any True", "Any False", or groups or "All" or "Any", with following THEN Save (waveforms), Stop, Alarm, (send) Pulse, Hardcopy (send email, save screen image, save to clipboard, send to printer), or (save) LabNotebook.

Display System

Size	Color 15.6" widescreen capacitive touch screen
Resolution	Full HD (1920 x 1080 pixels)
Number of Traces	Display a maximum of 40 traces. Simultaneously display channel, zoom, memory and math traces.
Grid Styles	Auto, Single, Dual, Quad, Octal, XY, Single+XY, Dual+XY, Tandem, Quatro, Twelve, Sixteen
Waveform Representation	Sample dots joined, or sample dots only

Processor/CPU

Type	Intel® Core i5-6500 Quad Core, 3.2 GHz (or better)
Processor Memory	16 GB standard
Operating System	Microsoft Windows® 10
Real Time Clock	Date and time displayed with waveform in hardcopy files. SNTP support to synchronize to precision internal clocks.

Connectivity

Ethernet Port	2 x 10/100/1000BaseT Ethernet interface (RJ45 port)
USB Host Ports	4 side USB 3.1 Gen1 ports, 3 front USB 3.1 Gen1 ports
USB Device Port	1 port - USBTMC over USB 3.1 Gen1
GPIO Port (Optional)	Supports IEEE-488.2 (External)
External Monitor Port	1 x DisplayPort, supports up to 4096x2304 @ 24 Hz 1 x HDMI, supports up to 4096x2304 @ 60 Hz
Remote Control	Via Windows Automation, or via LeCroy Remote Command Set
Network Communication Standard	VICP or VXI-11, LXI Compatible

Power Requirements

Voltage	90 to 264 Vrms, 47 to 63 Hz 90 to 132 Vrms, 380 to 420 Hz
Nominal Power Consumption	400 W / 400 VA
Max Power Consumption	525 W / 525 VA

Environmental

Temperature (Operating)	+5 °C to +40 °C
Temperature (Non-Operating)	-20 °C to +60 °C
Humidity (Operating)	5% to 90% relative humidity (non-condensing) up to +31 °C Upper limit derates to 50% relative humidity (non-condensing) at +40 °C
Humidity (Non-Operating)	5% to 95% relative humidity (non-condensing) as tested per MIL-PRF-28800F
Altitude (Operating)	Up to 10,000 ft (3048 m) at or below +30 °C
Altitude (Non-Operating)	Up to 40,000 ft (12,192 m)
Random Vibration (Operating)	0.31 grms 5 Hz to 500 Hz, 20 minutes in each of three orthogonal axes
Random Vibration (Non-Operating)	2.4 grms 5 Hz to 500 Hz, 15 minutes in each of three orthogonal axes
Functional Shock	30 g peak, half sine, 11 ms pulse, 3 shocks (positive and negative) in each of three orthogonal axes, 18 shocks total

Size and Weight

Dimensions (HWD)	13.6" H x 17.5" W x 7.7" D (345 mm x 445 mm x 196 mm)
Weight	24.4 lbs (11.1kg)

Certifications

CE Certification	CE compliant, UL and cUL listed; conforms to UL 61010-1 (3rd Edition), UL 61010-2-030 (1st Edition)
UL and cUL Listing	CAN/CSA C22.2 No. 61010-1-12

Warranty and Service

3-year warranty; calibration recommended annually. Optional service programs include extended warranty, upgrades, and calibration services.

Product Description	Product Code
WavePro HD Oscilloscopes	
2.5 GHz, 20 GS/s, 4 Ch, 100 Mpts/Ch High Definition Oscilloscope with 15.6" Full HD capacitive touch screen	WavePro 254HD
4 GHz, 20 GS/s, 4 Ch, 100 Mpts/Ch High Definition Oscilloscope with 15.6" Full HD capacitive touch screen	WavePro 404HD
6 GHz, 20 GS/s, 4 Ch, 100 Mpts/Ch High Definition Oscilloscope with 15.6" Full HD capacitive touch screen	WavePro 604HD
8 GHz, 20 GS/s, 4 Ch, 100 Mpts/Ch High Definition Oscilloscope with 15.6" Full HD capacitive touch screen	WavePro 804HD
2.5 GHz, 20 GS/s, 4 Ch, 100 Mpts/Ch High Definition Mixed Signal Oscilloscope with 15.6" Full HD capacitive touch screen	WavePro 254HD-MS
4 GHz, 20 GS/s, 4 Ch, 100 Mpts/Ch High Definition Mixed Signal Oscilloscope with 15.6" Full HD capacitive touch screen	WavePro 404HD-MS
6 GHz, 20 GS/s, 4 Ch, 100 Mpts/Ch High Definition Mixed Signal Oscilloscope with 15.6" Full HD capacitive touch screen	WavePro 604HD-MS
8 GHz, 20 GS/s, 4 Ch, 100 Mpts/Ch High Definition Mixed Signal Oscilloscope with 15.6" Full HD capacitive touch screen	WavePro 804HD-MS

Included with Standard Configurations (WavePro HD and WavePro HD-MS)

±10, 500 MHz Passive Probe (Qty. 4), Protective Cover, Getting Started Guide, Anti-virus Software (Trial Version), Microsoft Windows® 10, Commercial NIST Traceable Calibration with Certificate, Power Cable for the Destination Country, 3-year Warranty

Included with WavePro HD-MS

16-Channel Digital Leadset, Extra Large Gripper Probe Set (Qty. 22), Ground Extenders (Qty. 20), Flexible Ground Leads (Qty. 5)

Memory Options

200 Mpt/2 Ch (100 Mpt/4 Ch) Memory Option	WPHD-200MPT
500 Mpt/2 Ch (250 Mpt/4 Ch) Memory Option	WPHD-500MPT
1000 Mpt/2 Ch (500 Mpt/4 Ch) Memory Option	WPHD-1000MPT
2 Gpt/2 Ch (1 Gpt/4 Ch) Memory Option	WPHD-2000MPT
5 Gpt/2 Ch (2.5 Gpt/4 Ch) Memory Option	WPHD-5000MPT

CPU, Computer and Other Hardware Options

32 GB RAM Upgrade for WPHD	WPHD-UPG-32GBRAM
Additional Standard Solid State Drive	WPHD-RSSD-02

Product Description	Product Code
Serial Trigger and Decode	
MIL-STD-1553 Trigger and Decode Option	WPHD-1553 TD
MIL-STD-1553 Trigger, Decode, Measure/Graph, and Eye Diagram Option	WPHD-1553 TDME
8b10b Decode Option	WPHD-80B-8b10b D
ARINC 429 Bus Symbolic Decode, Measure/Graph, and Eye Diagram Option	WPHD-ARINC429BUS DME SYMBOLIC
ARINC 429 Bus Symbolic Decode Option	WPHD-ARINC429BUS D SYMBOLIC
AudioBus Trigger and Decode Option	WPHD-Audiobus TD
AudioBus trigger, decode, and graph Option	WPHD-Audiobus TDG
CAN FD Trigger and Decode Option	WPHD-CAN FDBUS TD
CAN FD Trigger, Decode, Measure/Graph, and Eye Diagram Option	WPHD-CAN FDBUS TDME
CAN FD Symbolic Trigger, Decode, and Measure/Graph, and Eye Diagram Option	WPHD-CAN FDBUS TDME SYMBOLIC
CAN Trigger & Decode Option	WPHD-CANBUS TD
CAN Trigger, Decode, Measure/Graph, and Eye Diagram Option	WPHD-CANBUS TDME
CAN Symbolic Trigger, Decode, and Measure/Graph, and Eye Diagram Option	WPHD-CANBUS TDME SYMBOLIC
DigRF 3G Bus Decode Option	WPHD-DigRF3Gbus D
DigRF V4 Bus Decode Option	WPHD-DigRFV4bus D
MIPI D-PHY CSI-2, DSI Bus Decode Option	WPHD-DPHYbus D
MIPI D-PHY CSI-2, DSI Bus Decode and Physical Layer Test Option	WPHD-DPHYbus DP
Bundle: includes I2C, SPI, UART-RS232 Trigger and Decode Option	WPHD-EMB TD
Bundle: includes I2C, SPI, UART-RS232 Trigger, Decode, Measure/Graph, and Eye Diagram Option	WPHD-EMB TDME
ENET Bus Decode Option	WPHD-ENETbus D
FibreChannel decode annotation Option	WPHD-FCbus D
FlexRay Trigger and Decode Option	WPHD-FLEXRAYBUS TD
FlexRay Trigger, Decode, Measure/Graph and Physical Layer Option	WPHD-FLEXRAYBUS TDMP
I2C Trigger and Decode Option	WPHD-I2CBUS TD
I2C Trigger, Decode, Measure/Graph, and Eye Diagram Option	WPHD-I2CBUS TDME
LIN Trigger and Decode Option	WPHD-LINBUS TD
LIN Trigger, Decode, Measure/Graph, and Eye Diagram Option	WPHD-LINBUS TDME
Manchester Bus Decode Option	WPHD-MANCHESTERbus D
MDIO Decode Option	WPHD-MDIOBUS D
MIPI M-PHY Bus Decode Option	WPHD-MPHYbus D
MIPI M-PHY Bus Decode and Physical Layer Test Option	WPHD-MPHYbus DP
NRZ Bus Decode Option	WPHD-NRZbus D
PCIe Gen 1 Decode Option	WPHD-PCIebus D
Serial Debug Toolkit - Measure Analyze Graph Option	WPHD-PROTOBUS MAG
Decode Annotation and Protocol Analyzer Synchronization Option	WPHD-ProtoSync
Decode Annotation and Protocol Analyzer+Bit Tracer Synchronization Option	WPHD-ProtoSync-BT
SAS Decode annotation Option	WPHD-SASbus D
SATA Decode Option	WPHD-SATABus D
SENT Bus Decode Option	WPHD-SENTbus D
SpaceWire Decode Option	WPHD-SPACEWIREbus D

Product Description **Product Code**

Serial Trigger and Decode (cont'd)

SPI Trigger and Decode Option	WPHD-SPIBUS TD
SPI Trigger, Decode, Measure/Graph, and Eye Diagram Option	WPHD-SPIBUS TDME
SPMI Decode Option	WPHD-SPMIbus D
UART-RS232 Trigger and Decode Option	WPHD-UART-RS232BUS TD
UART-RS232 Trigger, Decode, Measure/Graph, and Eye Diagram Option	WPHD-UART-RS232BUS TDME
MIPI UniPro Protocol Decoder Software Option	WPHD-UNIPRObus D
MPHY to UniPro Decoder Software Upgrade	WPHD-UPG-MPHY-UNIPRObus D
MPHY REQUIRED	
USB 2.0 Decode Option	WPHD-USB2BUS D
USB 2.0 Decode, Measure/Graph, and Eye Diagram Option	WPHD-USB2BUS DME
USB 2.0 HSIC Decode Option	WPHD-USB2-HSICbus D
USB 3.0 Decode Option	WPHD-USB3BUS D

Serial Data Compliance

QualiPHY Enabled BroadR-Reach Software Option	QPHY-BroadR-Reach
QualiPHY Enabled DDR2 Software Option	QPHY-DDR2
QualiPHY Enabled DDR3 Software Option	QPHY-DDR3
QualiPHY Enabled Ethernet 10/100/1000BT Software Option	QPHY-ENET*
QualiPHY Enabled LPDDR2 Software Option	QPHY-LPDDR2
QualiPHY Enabled MIPI D-PHY Software Option	QPHY-MIPI-DPHY
QualiPHY Enabled MOST150 Software Option	QPHY-MOST150
QualiPHY Enabled MOST50 Software Option	QPHY-MOST50
QualiPHY Enabled PCIe Software Option	QPHY-PCIE
QualiPHY Enabled USB 2.0 Software Option	QPHY-USB†
GRL USB Power Delivery Compliance Test Software	GRL-USB-PD
GRL USB Type-C Test Controller - US Power Cord	GRL-USB-PD-C1
10/100/1000Base-T Ethernet Test Fixture	TF-ENET-B**
USB 2.0 Compliance Test Fixture	TF-USB-B

* TF-ENET-B required † TF-USB-B required

** Includes ENET-2CAB-SMA018 and ENET-2ADA-BNCSMA

Product Description **Product Code**

DDR Debug Toolkits

DDR2 and LPDDR2 Debug Toolkit	WPHD-DDR2-TOOLKIT
DDR3, DDR3L, LPDDR3, DDR2, and LPDDR2 Debug Toolkit	WPHD-DDR3-TOOLKIT
DDR3, DDR3L, LPDDR3, DDR2, and LPDDR2 Debug Toolkit Upgrade	WPHD-UPG-DDR3-TOOLKIT

Serial Data Analysis

Single-Lane Serial Data Analysis, Eye, Jitter and Noise Measurements for WavePro HD	WPHD-SDAIII
Multi-Lane SDA LinQ incl. Eye, Jitter, Noise, Xtalk Meas, Eye Doctor II & VirtualProbe for WavePro HD	WPHD-SDAIII-COMPLETELINQ
Bundle: incl. Eye Doctor II and VirtualProbe Toolkits	WPHD-EYEDRII-VP
Eye Doctor II - Channel & Fixture	WPHD-EYEDRII
De-embedding/Emulation, Tx/Rx Equalization	
Advanced De-embedding, Emulation and Virtual Probing Toolkit	WPHD-VIRTUALPROBE
Serial Data Mask Software Package	WPHD-SDM
Cable De-Embedding Option	WPHD-CBL-DE-EMBED

Data Storage Software

Advanced Optical Recording Measurement Package	WPHD-AORM
Disk Drive Analyzer Software Package	WPHD-DDA
Disk Drive Measurements Software Package	WPHD-DDM2

Power Analysis Software

Power Analyzer Software Option	WPHD-PWR
Digital Power Management Analysis Option	WPHD-DIG-PWR-MGMT

Jitter Analysis Software

Clock, Clock-Data Jitter Analysis and Views of Time, Statistical, Spectral, and Jitter Overlay	WPHD-JITKIT
--	-------------

Digital Filtering Software

Digital Filter Software Option	WPHD-DFF2
--------------------------------	-----------

Other Software Options

EMC Pulse Parameter Software	WPHD-EMC
Electrical Telecom Pulse Mask Test	WPHD-ET-PMT
Spectrum Analyzer and Advanced FFT	WPHD-SPECTRUM
VectorLinQ Vector Signal Analysis	WPHD-VECTORLINQ
Advanced Customization	WPHD-XDEV

Remote Control/Network Options

External USB2 to GPIB Adaptor	USB2-GPIB
-------------------------------	-----------

General Accessories

WavePro HD Rackmount Kit	WPHD-RACKMOUNT
WavePro HD Carrying Case	WPHD-SOFTCASE

ORDERING INFORMATION



Product Description	Product Code
Probes	
Power/Voltage Rail Probe with 4 GHz bandwidth, 1.2x attenuation, ± 30 V offset, ± 800 mV	RP4030
High Voltage Fiber Optic Probe, 60 MHz bandwidth	HVFO103
500 MHz Passive Probe, 2.5mm, 10:1, 10 M Ω	PP023
500 MHz Passive Probe, 5mm, 10:1, 10 M Ω	PP026
1 GHz, 0.9 pF, 1 M Ω High Impedance Active Probe	ZS1000
Set of 4 ZS1000 Active Probes	ZS1000-QUADPAK
1.5 GHz, 0.9 pF, 1 M Ω High Impedance Active Probe	ZS1500
Set of 4 ZS1500 Active Probes	ZS1500-QUADPAK
2.5 GHz, 0.9 pF, 1 M Ω High Impedance Active Probe	ZS2500
Set of 4 ZS2500 Active Probes	ZS2500-QUADPAK
4 GHz, 0.6 pF, 1 M Ω High Impedance Active Probe	ZS4000
200 MHz, 3.5 pF, 1 M Ω Active Differential Probe, ± 20 V	ZD200
500 MHz, 1.0 pF Active Differential Probe, ± 8 V	ZD500
1 GHz, 1.0 pF Active Differential Probe, ± 8 V	ZD1000
1.5 GHz, 1.0 pF Active Differential Probe, ± 8 V	ZD1500
500 MHz, Active Differential Probe ($\div 1$, $\div 10$, $\div 100$)	AP033
4 GHz, 2.5 Vp-p ProBus2 Differential Probe	D410-A-PB2
4 GHz, 5 Vp-p ProBus2 Differential Probe	D420-A-PB2
4 GHz, ProBus2 Probe with Adjustable Tip	D400A-AT-PB2
6 GHz, 2.5 Vp-p ProBus2 Differential Probe	D610-A-PB2
6 GHz, 5 Vp-p ProBus2 Differential Probe	D620-A-PB2
6 GHz, ProBus2 Probe with Adjustable Tip	D600A-AT-PB2
8 GHz, 3.5 Vp-p Differential Probe System	D830-PB2
WaveLink ProBus2 Platform/Cable Assembly	WL-PBUS2
1 Ch, 100 MHz Differential Amplifier with Precision Voltage Source	DA1855A
DA1855A with Rackmount	DA1855A-RM
2 Ch, 100 MHz Differential Amplifier with Precision Voltage Source	DA1855A-PR2
DA1855A with Rackmount (must be ordered at time of purchase, no retrofit)	DA1855A-PR2-RM
30 A; 50 MHz Current Probe – AC/DC; 30 Arms; 50 A Peak Pulse	CP030
30 A, 10 MHz Current Probe - AC/DC, 30 Arms, 50 A Peak Pulse, 3-meter Cable	CP030-3M
30A, 50 MHz High Sensitivity Current Probe - AC/DC, 30 Arms, 50 A Peak Pulse, 1.5-meter Cable	CP030A
30 A; 100 MHz Current Probe – AC/DC; 30 Arms; 50 A Peak Pulse	CP031
30A, 100 MHz High Sensitivity Current Probe - AC/DC, 30 Arms, 50 A Peak Pulse, 1.5-meter Cable	CP031A
150 A; 10 MHz Current Probe – AC/DC; 150 Arms; 500 A Peak Pulse	CP150
150 A, 5 MHz Current Probe - AC/DC, 150 Arms, 500 A Peak Pulse, 6-meter Cable	CP150-6M
500 A; 2 MHz Current Probe – AC/DC; 500 Arms; 700 A Peak Pulse	CP500
Deskew Calibration Source	DCS025
Programmable Current Sensor to ProBus Adapter (for third-party current sensors)	CA10
Set of 4 CA10 Programmable Current Sensor to ProBus Adapters (for third-party current sensors)	CA10-QUADPAK
100:1 400 MHz 50 M Ω 1 kV High-Voltage Probe	HVP120
100:1 400 MHz 50 M Ω 4 kV High-Voltage Probe	PPE4KV
1000:1 400 MHz 50 M Ω 5 kV High-Voltage Probe	PPE5KV
1000:1 400 MHz 5 M Ω / 50 M Ω 6 kV High-Voltage Probe	PPE6KV

Product Description	Product Code
Probes (cont'd)	
TekProbe to ProBus Probe Adapter	TPA10
Set of 4 TPA10 TekProbe to ProBus Probe Adapters (includes soft carrying case)	TPA10-QUADPAK
Optical-to-Electrical Converter, 500-870 nm ProBus BNC Connector	OE425
Optical-to-Electrical Converter, 950-1630 nm ProBus BNC Connector	OE455
1 kV, 25 MHz High Voltage Differential Probe	HVD3102A
1 kV, 25 MHz High Voltage Differential Probe (without tip accessories)	HVD3102A-NOACC
1 kV, 120 MHz High Voltage Differential Probe	HVD3106A
1 kV, 120 MHz High Voltage Differential Probe (without tip accessories)	HVD3106A-NOACC
1 kV, 80 MHz High Voltage Differential Probe with 6-meter Cable and Auto Zero Disconnect	HVD3106A-6M
2 kV, 120 MHz High Voltage Differential Probe	HVD3206A
2 kV, 80 MHz High Voltage Differential Probe with 6-meter Cable	HVD3206A-6M
6 kV, 100 MHz High Voltage Differential Probe	HVD3605A
7.5 GHz Low Capacitance Passive Probe ($\div 10$, 1 k Ω ; ± 20 , 500 Ω)	PP066



1-800-5-LeCroy
teledynelecroy.com

Local sales offices are located throughout the world.
Visit our website to find the most convenient location.

© 2018 by Teledyne LeCroy, Inc. All rights reserved. Specifications, prices, availability, and delivery subject to change without notice. Product or brand names are trademarks or requested trademarks of their respective holders.

PCI Express® is a registered trademark and/or service mark of PCI-SIG.

MATLAB® is a registered trademark of The MathWorks, Inc. All other product or brand names are trademarks or requested trademarks of their respective holders.

waveprohd-ds-03may18